

Konfigurierbare Systemsoftware (KSS)

VL 3 – Aspect-Oriented Programming (AOP)

Daniel Lohmann

Lehrstuhl für Informatik 4
Verteilte Systeme und Betriebssysteme

Friedrich-Alexander-Universität
Erlangen-Nürnberg

SS 15 – 2015-04-28

http://www4.informatik.uni-erlangen.de/Lehre/SS15/V_KSS



About this Lecture

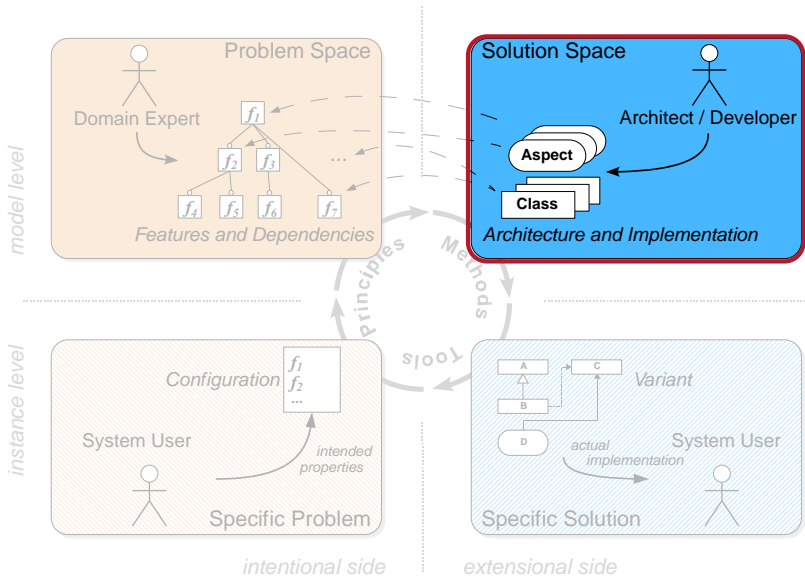

Implementation Techniques: Classification

Decompositional Approaches

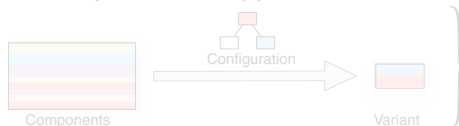

- Text-based filtering (untyped)
- Preprocessors

Compositional Approaches

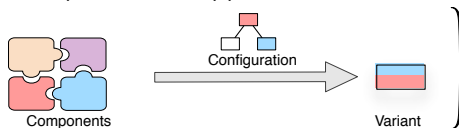

- Language-based composition mechanisms (typed)
- OOP, **AOP**, Templates

Generative Approaches

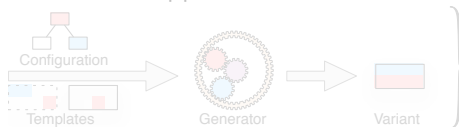

- Metamodel-based generation of components (typed)
- MDD, C++ TMP, generators



Agenda

- 3.1 Motivation: Separation of Concerns
- 3.2 Tutorial: AspectC++
- 3.3 Summary and Outlook
- 3.4 References



3.1 Motivation: Separation of Concerns

Example: I4WeatherMon

Example: eCos

AOP

3.2 Tutorial: AspectC++

3.3 Summary and Outlook

3.4 References



Static Configurability with the CPP?

I4WeatherMon (CPP): Implementation (Excerpt)

```
.....
#include <string>
#include <vector>
#include <list>
#include <map>
#include <memory>
#include <algorithm>
#include <numeric>
#include <functional>
#include <string_view>
#include <string_view_literals>
#include <string_view_literals>
.....
// Constructor
WeatherMon() : m_wind_sensor(nullptr), m_temperature_sensor(nullptr), m_wind_display(nullptr), m_temperature_display(nullptr), m_wind_counter(0), m_temperature_counter(0) {}
// Destructor
~WeatherMon() {}
// Add sensor
void AddSensor(const string& name, const string& unit, const string& display_name) {
    m_sensors.push_back({name, unit, display_name});
}
// Add display
void AddDisplay(const string& name, const string& unit, const string& display_name) {
    m_displays.push_back({name, unit, display_name});
}
// Add connection
void AddConnection(const string& name, const string& unit, const string& display_name) {
    m_connections.push_back({name, unit, display_name});
}
// Get weather data
vector<WeatherData> GetWeatherData() const {
    return m_weather_data;
}
// Get sensor data
vector<SensorData> GetSensorData() const {
    return m_sensor_data;
}
// Get display data
vector<DisplayData> GetDisplayData() const {
    return m_display_data;
}
// Get connection data
vector<ConnectionData> GetConnectionData() const {
    return m_connection_data;
}
// Get weather data
vector<WeatherData> GetWeatherData() const {
    return m_weather_data;
}
// Get sensor data
vector<SensorData> GetSensorData() const {
    return m_sensor_data;
}
// Get display data
vector<DisplayData> GetDisplayData() const {
    return m_display_data;
}
// Get connection data
vector<ConnectionData> GetConnectionData() const {
    return m_connection_data;
}
// Get weather data
vector<WeatherData> GetWeatherData() const {
    return m_weather_data;
}
// Get sensor data
vector<SensorData> GetSensorData() const {
    return m_sensor_data;
}
// Get display data
vector<DisplayData> GetDisplayData() const {
    return m_display_data;
}
// Get connection data
vector<ConnectionData> GetConnectionData() const {
    return m_connection_data;
}
.....
```

I4WeatherMon example from last lecture



- The **e** embedded **C**onfigurable **o**perating **s**ystem
 - Operating system for embedded applications
 - Open source, maintained by eCosCentric Inc.
 - Many 16-bit and 32-bit platforms supported
 - Broadly accepted real-world system
- More than **750** configuration options (kernel)
 - Feature-based selection
 - **Preprocessor-based** implementation

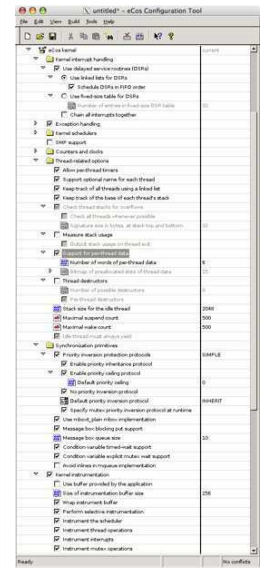

Static Configurability with the CPP?

```
Cyg_Mutex::Cyg_Mutex() {
    CYG_REPORT_FUNCTION();
    locked      = false;
    owner       = NULL;
    #if defined(CYGSEM_KERNEL_SYNCH_MUTEX_PRIORITY_INVERSION_PROTOCOL_DEFAULT) && \
        defined(CYGSEM_KERNEL_SYNCH_MUTEX_PRIORITY_INVERSION_PROTOCOL_DYNAMIC)
    #ifdef CYGSEM_KERNEL_SYNCH_MUTEX_PRIORITY_INVERSION_PROTOCOL_DEFAULT_INHERIT
        protocol = INHERIT;
    #endif
    #ifdef CYGSEM_KERNEL_SYNCH_MUTEX_PRIORITY_INVERSION_PROTOCOL_DEFAULT_CEILING
        protocol = CEILING;
        ceiling  = CYGSEM_KERNEL_SYNCH_MUTEX_PRIORITY_INVERSION_PROTOCOL_DEFAULT_PRIORITY;
    #endif
    #ifdef CYGSEM_KERNEL_SYNCH_MUTEX_PRIORITY_INVERSION_PROTOCOL_DEFAULT_NONE
        protocol = NONE;
    #endif
    #else // not (DYNAMIC and DEFAULT defined)
    #ifdef CYGSEM_KERNEL_SYNCH_MUTEX_PRIORITY_INVERSION_PROTOCOL_CEILING
    #ifdef CYGSEM_KERNEL_SYNCH_MUTEX_PRIORITY_INVERSION_PROTOCOL_DEFAULT_PRIORITY
        // if there is a default priority ceiling defined, use that to initialize
        // the ceiling.
        ceiling = CYGSEM_KERNEL_SYNCH_MUTEX_PRIORITY_INVERSION_PROTOCOL_DEFAULT_PRIORITY;
    #else
        // Otherwise set it to zero.
        ceiling = 0;
    #endif
    #endif
    #endif // DYNAMIC and DEFAULT defined
    CYG_REPORT_RETURN();
}
```

Mutex
options:

PROTOCOL

CEILING

INHERIT

DYNAMIC

Kernel policies:

Tracing

Instrumentation

Synchronization

Static Configurability with the CPP?

```
Cyg_Mutex::Cyg_Mutex() {
  CYG_REPORT_FUNCTION();
  locked      = false;
  owner       = NULL;
  #if defined(CYGSEM_KERNEL_SYNCH_MUTEX_PRIORITY_INVERSION_PROTOCOL_DEFAULT) && \
  defined(CYGSEM_KERNEL_SYNCH_MUTEX_PRIORITY_INVERSION_PROTOCOL_DYNAMIC)
  #ifdef CYGSEM_KERNEL_SYNCH_MUTEX_PRIORITY_INVERSION_PROTOCOL_DEFAULT_INHERIT
    protocol   = INHERIT;
  #endif
  #ifdef CYGSEM_KERNEL_SYNCH_MUTEX_PRIORITY_INVERSION_PROTOCOL_DEFAULT_CEILING
    protocol   = CEILING;
    ceiling    = CYGSEM_KERNEL_SYNCH_MUTEX_PRIORITY_INVERSION_PROTOCOL_DEFAULT_PRIORITY;
  #endif
  #ifdef CYGSEM_KERNEL_SYNCH_MUTEX_PRIORITY_INVERSION_PROTOCOL_DEFAULT_NONE
    protocol   = NONE;
  #endif
  #else // not (DYNAMIC and DEFAULT) defined
  #ifdef CYGSEM_KERNEL_SYNCH_MUTEX_PRIORITY_INVERSION_PROTOCOL_DEFAULT_CEILING
    protocol   = CEILING;
  #endif
  #ifdef CYGSEM_KERNEL_SYNCH_MUTEX_PRIORITY_INVERSION_PROTOCOL_DEFAULT_PRIORITY
    // if there is a default priority ceiling defined, use that to initialize
    // the ceiling.
    ceiling    = CYGSEM_KERNEL_SYNCH_MUTEX_PRIORITY_INVERSION_PROTOCOL_DEFAULT_PRIORITY;
  #else
    // Otherwise set it to zero.
    ceiling    = 0;
  #endif
  #endif
  #endif // DYNAMIC and DEFAULT defined
  CYG_REPORT_RETURN();
}
```

```
Cyg_Mutex::Cyg_Mutex() {
  locked      = false;
  owner       = NULL;
}
```

Mutex options:

PROTOCOL

CEILING

INHERIT

DYNAMIC

Kernel policies:

Tracing

Instrumentation

Synchronization

Static Configurability with the CPP?

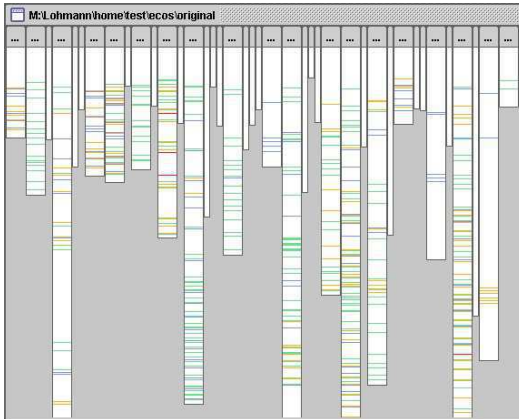

Mutex options:

PROTOCOL

CEILING

INHERIT

DYNAMIC

Kernel policies:

Tracing

Instrumentation

Synchronization



Static Configurability with the CPP?

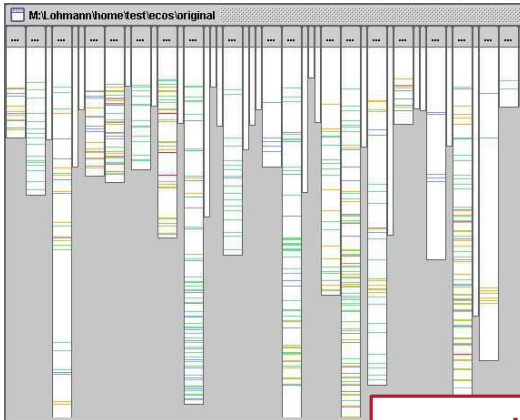

Mutex options:

PROTOCOL

CEILING

INHERIT

DYNAMIC

Issue

Crosscutting Concerns

Kernel policies:

Tracing

Instrumentation

Synchronization



Aspect-Oriented Programming

- AOP is about modularizing crosscutting concerns

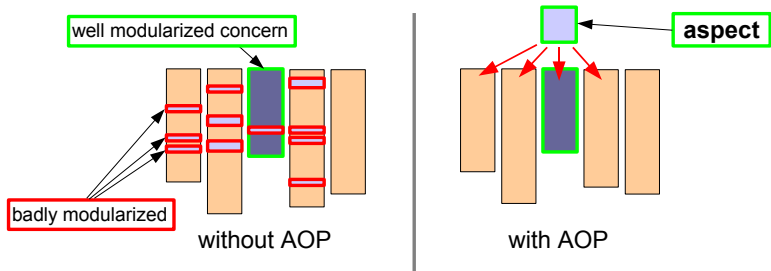

- Examples: tracing, synchronization, security, buffering, error handling, constraint checks, ...



Separation of **what** from **where**:

- **Join Points** \mapsto **where**
 - positions in the static structure or dynamic control flow (event)
 - given declaratively by pointcut expressions
- **Advice** \mapsto **what**
 - additional elements (members, ...) to introduce at join points
 - additional behavior (code) to superimpose at join points



Static Configurability with the CPP?

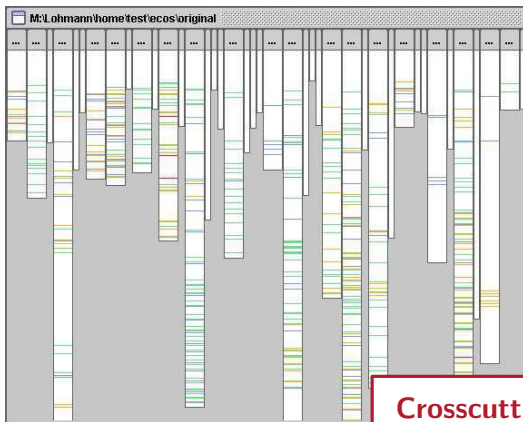

Mutex options:

PROTOCOL

CEILING

INHERIT

DYNAMIC

Crosscutting Concerns

Can we do better with aspects?

Kernel policies:

Tracing

Instrumentation

Synchronization



Implementation of Crosscutting Concerns with AOP

```
aspect int_sync {
```

```
    pointcut sync() = execution(...) // kernel calls to sync
        || construction(...)
        || destruction(...);
```

where

```
    // advise kernel code to invoke lock() and unlock()
    advice sync() : before() {
        Cyg_Scheduler::lock();
    }
    advice sync() : after() {
        Cyg_Scheduler::unlock();
    }
```

what

```
    // In eCos, a new thread always starts with a lock value of 0
    advice execution(
        "%Cyg_HardwareThread::thread_entry(...)") : before() {
        Cyg_Scheduler::zero_sched_lock();
    }
    ...
};
```



Synchronization



Static Configurability with the CPP?

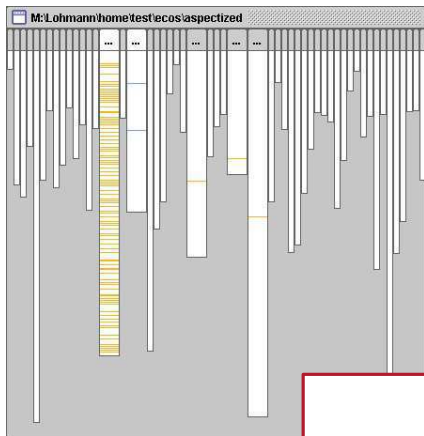

Result
after refactoring
into aspects [4]

Kernel policies:

Tracing

Instrumentation

Synchronization



- AspectC++ is an AOP language extension for C++
 - superset of ISO C++ 98 [1]
 - ↪ every C++ program is also an AspectC++ program
 - additionally supports AOP concepts
- Technical approach: source-to-source transformation
 - *ac++ weaver* transforms AspectC++ code into C++ code
 - resulting C++ code can be compiled with any standard-compliant compiler (especially gcc)
 - *ag++ weaver wrapper* works as replacement for *g++* in makefiles
- Language and weaver are open source (GPL2)



<http://www.aspectc.org>



3.1 Motivation: Separation of Concerns

3.2 Tutorial: AspectC++

Example Szenario

First Steps And Language Overview

Advanced Concepts

Weaver Transformations

Further Examples

3.3 Summary and Outlook

3.4 References



Scenario: A Queue utility class

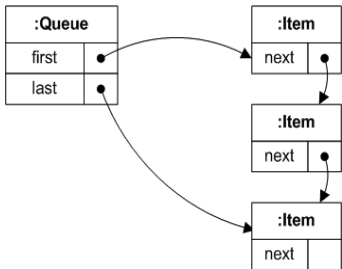
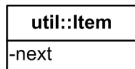
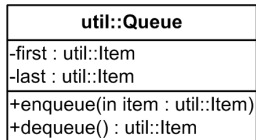

The Simple Queue Class

```
namespace util {
    class Item {
        friend class Queue;
        Item* next;
    public:
        Item() : next(0){}
    };

    class Queue {
        Item* first;
        Item* last;
    public:
        Queue() : first(0), last(0) {}

        void enqueue( Item* item ) {
            printf( " > Queue::enqueue()\n" );
            if( last ) {
                last->next = item;
                last = item;
            } else
                last = first = item;
            printf( " < Queue::enqueue()\n" );
        }
    };
}
```

```
Item* dequeue() {
    printf(" > Queue::dequeue()\n");
    Item* res = first;
    if( first == last )
        first = last = 0;
    else
        first = first->next;
    printf(" < Queue::dequeue()\n");
    return res;
}
}; // class Queue
} // namespace util
```



Scenario: The Problem

Various users of Queue demand extensions:



I want Queue to throw exceptions!

Please extend the Queue class by an element counter!



Queue should be thread-safe!



The Not So Simple Queue Class

```
class Queue {
    Item *first, *last;
    int counter;
    os::Mutex lock;
public:
    Queue () : first(0), last(0) {
        counter = 0;
    }
    void enqueue(Item* item) {
        lock.enter();
        try {
            if (item == 0)
                throw QueueInvalidItemError();
            if (last) {
                last->next = item;
                last = item;
            } else { last = first = item; }
            ++counter;
        } catch (...) {
            lock.leave(); throw;
        }
        lock.leave();
    }
}
```

```
Item* dequeue() {
    Item* res;
    lock.enter();
    try {
        res = first;
        if (first == last)
            first = last = 0;
        else first = first->next;
        if (counter > 0) --counter;
        if (res == 0)
            throw QueueEmptyError();
    } catch (...) {
        lock.leave();
        throw;
    }
    lock.leave();
    return res;
}
int count() { return counter; }
}; // class Queue
```



What Code Does What?

```
class Queue {
    Item *first, *last;
    int counter;
    os::Mutex lock;
public:
    Queue () : first(0), last(0) {
        counter = 0;
    }
    void enqueue(Item* item) {
        lock.enter();
        try {
            if (item == 0)
                throw QueueInvalidItemError();
            if (last) {
                last->next = item;
                last = item;
            } else { last = first = item; }
            ++counter;
        } catch (...) {
            lock.leave(); throw;
        }
        lock.leave();
    }
}
```

```
Item* dequeue() {
    Item* res;
    lock.enter();
    try {
        res = first;
        if (first == last)
            first = last = 0;
        else first = first->next;
        if (counter > 0) --counter;
        if (res == 0)
            throw QueueEmptyError();
    } catch (...) {
        lock.leave();
        throw;
    }
    lock.leave();
    return res;
}
int count() { return counter; }
}; // class Queue
```



Problem Summary

The component code is “polluted” with code for several logically independent concerns, thus it is ...

- hard to **write** the code
 - many different things have to be considered simultaneously
- hard to **read** the code
 - many things are going on at the same time
- hard to **maintain** and **evolve** the code
 - the implementation of concerns such as locking is **scattered** over the entire source base (a “*crosscutting concern*”)
- hard to **configure** at compile time
 - the users get a “one fits all” queue class



Goal: A configurable Queue

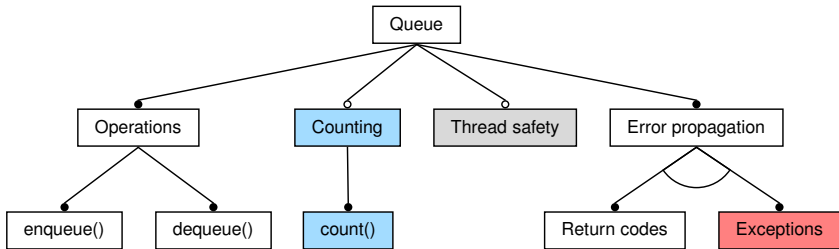

Configuring with the Preprocessor?

```
class Queue {
    Item *first, *last;
#ifdef COUNTING_ASPECT
    int counter;
#endif
#ifdef LOCKING_ASPECT
    os::Mutex lock;
#endif
public:
    Queue () : first(0), last(0) {
#ifdef COUNTING_ASPECT
        counter = 0;
#endif
    }
    void enqueue(Item* item) {
#ifdef LOCKING_ASPECT
        lock.enter();
        try {
#endif
#ifdef ERRORHANDLING_ASPECT
            if (item == 0)
                throw QueueInvalidItemError();
#endif
            if (last) {
                last->next = item;
                last = item;
            } else { last = first = item; }
#ifdef COUNTING_ASPECT
            ++counter;
#endif
#ifdef LOCKING_ASPECT
        } catch (...) {
            lock.leave(); throw;
        }
        lock.leave();
#endif
    }
}
```

```
Item* dequeue() {
    Item* res;
#ifdef LOCKING_ASPECT
    lock.enter();
    try {
#endif
        res = first;
        if (first == last)
            first = last = 0;
        else first = first->next;
#ifdef COUNTING_ASPECT
        if (counter > 0) --counter;
#endif
#ifdef ERRORHANDLING_ASPECT
        if (res == 0)
            throw QueueEmptyError();
#endif
#ifdef LOCKING_ASPECT
    } catch (...) {
        lock.leave();
        throw;
    }
    lock.leave();
#endif
    return res;
}
#ifdef COUNTING_ASPECT
int count() { return counter; }
#endif
}; // class Queue
```



3.1 Motivation: Separation of Concerns

3.2 Tutorial: AspectC++

Example Szenario

First Steps And Language Overview

Advanced Concepts

Weaver Transformations

Further Examples

3.3 Summary and Outlook

3.4 References



Queue: Demanded Extensions

I. Element counting

Please extend
the Queue class
by an element
counter!



II. Errorhandling (signaling of errors by exceptions)

III. Thread safety (synchronization by mutex variables)



Element counting: The Idea

- Increment a counter variable after each execution of `util::Queue::enqueue()`
- Decrement it after each execution of `util::Queue::dequeue()`



ElementCounter1

```
aspect ElementCounter {  
  
    int counter;  
    ElementCounter() {  
        counter = 0;  
    }  
  
    advice execution("% util::Queue::enqueue(...)") : after() {  
        ++counter;  
        printf( " Aspect ElementCounter: # of elements = %d\n", counter );  
    }  
    advice execution("% util::Queue::dequeue(...)") : after() {  
        if( counter > 0 ) --counter;  
        printf( " Aspect ElementCounter: # of elements = %d\n", counter );  
    }  
};
```

ElementCounter1.ah



ElementCounter1 - Elements

```
aspect ElementCounter {
```

```
    int counter;  
    ElementCounter() {  
        counter = 0;  
    }  
};
```

We introduced a new **aspect** named *ElementCounter*.

An aspect starts with the keyword **aspect** and is syntactically much like a class.

```
    advice execution("% util::Queue::enqueue(...)") : after() {  
        ++counter;  
        printf( " Aspect ElementCounter: # of elements = %d\n", counter );  
    }  
    advice execution("% util::Queue::dequeue(...)") : after() {  
        if( counter > 0 ) --counter;  
        printf( " Aspect ElementCounter: # of elements = %d\n", counter );  
    }  
};
```

ElementCounter1.ah



ElementCounter1 - Elements

```
aspect ElementCounter {
```

```
    int counter;  
    ElementCounter() {  
        counter = 0;  
    }
```

Like a class, an aspect can define data members, constructors and so on

```
    advice execution("% util::Queue::enqueue(...)") : after() {  
        ++counter;  
        printf( " Aspect ElementCounter: # of elements = %d\n", counter );  
    }  
    advice execution("% util::Queue::dequeue(...)") : after() {  
        if( counter > 0 ) --counter;  
        printf( " Aspect ElementCounter: # of elements = %d\n", counter );  
    }  
};
```

ElementCounter1.ah



ElementCounter1 - Elements

```
aspect ElementCounter {  
    int counter;  
    ElementCounter() {  
        counter = 0;  
    }  
    advice execution("% util::Queue::enqueue(...)") : after() {  
        ++counter;  
        printf( " Aspect ElementCounter: # of elements = %d\n", counter );  
    }  
    advice execution("% util::Queue::dequeue(...)") : after() {  
        if( counter > 0 ) --counter;  
        printf( " Aspect ElementCounter: # of elements = %d\n", counter );  
    }  
};
```

We give **after advice** (= some crosscutting code to be executed after certain control flow positions)

ElementCounter1.ah



ElementCounter1 - Elements

This **pointcut expression** denotes where the advice should be given. (After **execution** of methods that match the pattern)

```
aspect ElementCounter {  
    int counter;  
    ElementCounter() {  
        counter = 0;  
    }  
  
    advice execution("% util::Queue::enqueue(...)") : after() {  
        ++counter;  
        printf( " Aspect ElementCounter: # of elements = %d\n", counter );  
    }  
    advice execution("% util::Queue::dequeue(...)") : after() {  
        if( counter > 0 ) --counter;  
        printf( " Aspect ElementCounter: # of elements = %d\n", counter );  
    }  
};
```

ElementCounter1.ah



ElementCounter1 - Elements

```
aspect ElementCounter {  
  
    int counter;  
    ElementCounter() {  
        counter = 0;  
    }  
  
    advice execution("% util::Queue::enqueue(...)") : after() {  
        ++counter;  
        printf( " Aspect ElementCounter: # of elements = %d\n", counter );  
    }  
    advice execution("% util::Queue::dequeue(...)") : after() {  
        if( counter > 0 ) --counter;  
        printf( " Aspect ElementCounter: # of elements = %d\n", counter );  
    }  
};
```

Aspect member elements can be accessed from within the advice body

ElementCounter1.ah



ElementCounter1 - Result

```
int main() {
    util::Queue queue;

    printf("main(): enqueueing an item\n");
    queue.enqueue( new util::Item );

    printf("main(): dequeueing two items\n");
    Util::Item* item;
    item = queue.dequeue();
    item = queue.dequeue();
}
```

main.cc

```
main(): enqueueing an item
> Queue::enqueue(00320FD0)
< Queue::enqueue(00320FD0)
Aspect ElementCounter: # of elements = 1
main(): dequeueing two items
> Queue::dequeue()
< Queue::dequeue() returning 00320FD0
Aspect ElementCounter: # of elements = 0
> Queue::dequeue()
< Queue::dequeue() returning 00000000
Aspect ElementCounter: # of elements = 0
```

<Output>



ElementCounter1 – What's next?

- The aspect is not the ideal place to store the counter, because it is shared between all Queue instances
- Ideally, counter becomes a member of Queue
- In the next step, we
 - move counter into Queue by **introduction**
 - **expose context** about the aspect invocation to access the current Queue instance



ElementCounter2

```
aspect ElementCounter {  
  
    advice "util::Queue" : slice class {  
        int counter;  
    public:  
        int count() const { return counter; }  
    };  
    advice execution("% util::Queue::enqueue(...)")  
        && that(queue) : after( util::Queue& queue ) {  
        ++queue.counter;  
        printf( " Aspect ElementCounter: # of elements = %d\n", queue.count() );  
    }  
    advice execution("% util::Queue::dequeue(...)")  
        && that(queue) : after( util::Queue& queue ) {  
        if( queue.count() > 0 ) --queue.counter;  
        printf( " Aspect ElementCounter: # of elements = %d\n", queue.count() );  
    }  
    advice construction("util::Queue")  
        && that(queue) : before( util::Queue& queue ) {  
        queue.counter = 0;  
    }  
};
```

ElementCounter2.ah



ElementCounter2 - Elements

```
aspect ElementCounter {  
  
    advice "util::Queue" : slice class {  
        int counter;  
        public:  
        int count() const { return counter; }  
    };  
    advice execution("% util::Queue::enqueue(...)")  
        && that(queue) : after( util::Queue& queue ) {  
        ++queue.counter;  
        printf( " Aspect ElementCounter: # of elements = %d\n", queue.count() );  
    }  
    advice execution("% util::Queue::dequeue(...)")  
        && that(queue) : after( util::Queue& queue ) {  
        if( queue.count() > 0 ) --queue.counter;  
        printf( " Aspect ElementCounter: # of elements = %d\n", queue.count() );  
    }  
    advice construction("util::Queue")  
        && that(queue) : before( util::Queue& queue ) {  
        queue.counter = 0;  
    }  
};
```

Introduces a **slice** of members into all classes denoted by the pointcut "util::Queue"

ElementCounter2.ah



ElementCounter2 - Elements

```
aspect ElementCounter {  
  
    advice "util::Queue" : slice class {  
        int counter;  
        public:  
        int count() const { return counter; }  
    };  
    advice execution("% util::Queue::enqueue(...)")  
        && that(queue) : after( util::Queue& queue ) {  
        ++queue.counter;  
        printf( " Aspect ElementCounter: # of elements = %d\n", queue.count() );  
    }  
    advice execution("% util::Queue::dequeue(...)")  
        && that(queue) : after( util::Queue& queue ) {  
        if( queue.count() > 0 ) --queue.counter;  
        printf( " Aspect ElementCounter: # of elements = %d\n", queue.count() );  
    }  
    advice construction("util::Queue")  
        && that(queue) : before( util::Queue& queue ) {  
        queue.counter = 0;  
    }  
};
```

We introduce a private *counter* element and a public method to read it

ElementCounter2.ah



ElementCounter2 - Elements

```
aspect ElementCounter {  
    advice "util::Queue" : slice class {  
        int counter;  
        public:  
        int count() const { return counter; }  
    };  
    advice execution("% util::Queue::enqueue(...)"  
        && that(queue) : after( util::Queue& queue ) {  
        ++queue.counter;  
        printf( " Aspect ElementCounter: # of elements = %d\n", queue.count() );  
    }  
    advice execution("% util::Queue::dequeue(...)"  
        && that(queue) : after( util::Queue& queue ) {  
        if( queue.count() > 0 ) --queue.counter;  
        printf( " Aspect ElementCounter: # of elements = %d\n", queue.count() );  
    }  
    advice construction("util::Queue")  
        && that(queue) : before( util::Queue& queue ) {  
        queue.counter = 0;  
    }  
};
```

A **context variable** *queue* is bound to *that* (the calling instance).

The calling instance has to be an `util::Queue`

ElementCounter2.ah



ElementCounter2 - Elements

```
aspect ElementCounter {  
  
  advice "util::Queue" : slice class {  
    int counter;  
    public:  
    int count() const { return counter; }  
  };  
  advice execution("% util::Queue::enqueue(...)")  
    && that(queue) : after( util::Queue& queue ) {  
    ++queue.counter;  
    printf( " Aspect ElementCounter: # of elements = %d\n", queue.count() );  
  }  
  advice execution("% util::Queue::dequeue(...)")  
    && that(queue) : after( util::Queue& queue ) {  
    if( queue.count() > 0 ) --queue.counter;  
    printf( " Aspect ElementCounter: # of elements = %d\n", queue.count() );  
  }  
  advice construction("util::Queue")  
    && that(queue) : before( util::Queue& queue ) {  
    queue.counter = 0;  
  }  
};
```

The context variable *queue* is used to access the calling instance.

ElementCounter2.ah



ElementCounter2 - Elements

```
aspect ElementCounter {  
  
    advice "util::Queue" : slice class {  
        int counter;  
    public:  
        int count() const { return counter; }  
    };  
    advice execution("% util::Queue::enqueue(...)")  
        && that(queue) : after( util::Queue& queue ) {  
        ++queue.counter;  
        printf( " Aspect ElementCounter: # of elements = %d\n", queue.count() );  
    }  
    advice execution("% util::Queue::dequeue(...)")  
        && that(queue) : after( util::Queue& queue ) {  
        if( queue.count() > 0 ) --queue.counter;  
        printf( " Aspect ElementCounter: # of elements = %d\n", queue.count() );  
    }  
    advice construction("util::Queue")  
        && that(queue) : before( util::Queue& queue ) {  
        queue.counter = 0;  
    }  
};
```

By giving **construction advice** we ensure that counter gets initialized

ElementCounter2.ah



ElementCounter2 - Result

```
int main() {
    util::Queue queue;
    printf("main(): Queue contains %d items\n", queue.count());
    printf("main(): enqueueing some items\n");
    queue.enqueue(new util::Item);
    queue.enqueue(new util::Item);
    printf("main(): Queue contains %d items\n", queue.count());
    printf("main(): dequeuing one item\n");
    util::Item* item;
    item = queue.dequeue();
    printf("main(): Queue contains %d items\n", queue.count());
}
```

main.cc



ElementCounter2 - Result

```
int main() {
    util::Queue queue;
    printf("main(): Queue contains %d items\n", queue.count());
    printf("main(): enqueueing some items\n");
    queue.enqueue(new util::Item);
    queue.enqueue(new util::Item);
    printf("main(): Queue contains %d items\n", queue.count());
    printf("main(): dequeueing one item\n");
    util::Item* item;
    item = queue.dequeue();
    printf("main(): Queue contains %d items\n", queue.count());
}
```

main.cc

```
main(): Queue contains 0 items
main(): enqueueing some items
> Queue::enqueue(00320FD0)
< Queue::enqueue(00320FD0)
Aspect ElementCounter: # of elements = 1
> Queue::enqueue(00321000)
< Queue::enqueue(00321000)
Aspect ElementCounter: # of elements = 2
main(): Queue contains 2 items
main(): dequeueing one item
> Queue::dequeue()
< Queue::dequeue() returning 00320FD0
Aspect ElementCounter: # of elements = 1
main(): Queue contains 1 items
```

<Output>



ElementCounter – Lessons Learned

You have seen...

- the most important concepts of AspectC++
 - Aspects are introduced with the keyword *aspect*
 - They are much like a class, may contain methods, data members, types, inner classes, etc.
 - Additionally, aspects can give *advice* to be woven in at certain positions (*joinpoints*). Advice can be given to
 - Functions/Methods/Constructors: code to execute (*code advice*)
 - Classes or structs: new elements (*introductions*)
 - Joinpoints are described by *pointcut expressions*

- We will now take a closer look at some of them



Syntactic Elements

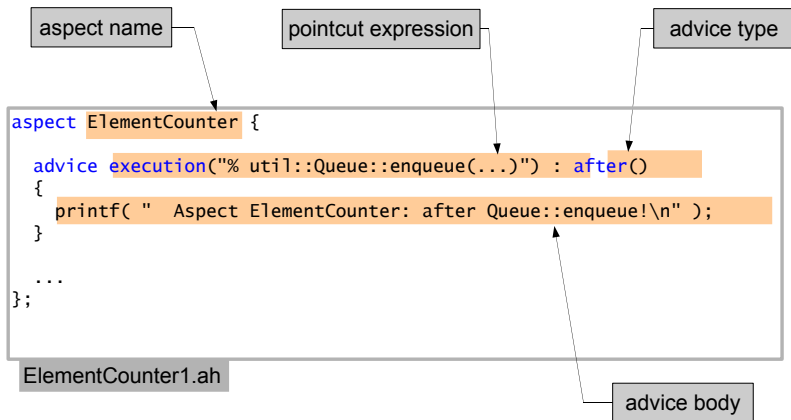

Joinpoints

- A **joinpoint** denotes a position to give advice
 - **Code** joinpoint
 - a point in the **control flow** of a running program, e.g.
 - **execution** of a function
 - **call** of a function
 - **Name** joinpoint
 - a **named C++ program entity** (identifier)
 - class, function, method, type, namespace
- Joinpoints are given by **pointcut expressions**
 - a pointcut expression describes a **set of joinpoints**



Pointcut Expressions

- Pointcut expressions are made from ...
 - **match expressions**, e.g. "% util::queue::enqueue(...)"
 - are matched against C++ programm entities → name joinpoints
 - support wildcards
 - **pointcut functions**, e.g. execution(...), call(...), that(...)
 - **execution**: all points in the control flow, where a function is about to be executed → code joinpoints
 - **call**: all points in the control flow, where a function is about to be called → code joinpoints
- Pointcut functions can be combined into expressions
 - using logical connectors: &&, ||, !
 - Example: call("% util::Queue::enqueue(...)") && within("% main(...)")



Advice

Advice to functions

- **before advice**
 - Advice code is executed **before** the original code
 - Advice may read/modify parameter values
- **after advice**
 - Advice code is executed **after** the original code
 - Advice may read/modify return value
- **around advice**
 - Advice code is executed **instead of** the original code
 - Original code may be called explicitly: `tjp->proceed()`

Introductions

- A *slice* of additional methods, types, etc. is added to the class
- Can be used to extend the interface of a class



Before / After Advice

with execution joinpoints:

advice execution("void ClassA::foo()") : **before**()

advice execution("void ClassA::foo()") : **after**()

```
class ClassA {  
public:  
    void foo(){  
        printf("ClassA::foo()\n");  
    }  
}
```

with call joinpoints:

advice call ("void ClassA::foo()") : **before**()

advice call ("void ClassA::foo()") : **after**()

```
int main(){  
    printf("main()\n");  
    ClassA a;  
    a.foo();  
}
```



Around Advice

with execution joinpoints:

```
advice execution("void ClassA::foo()") : around()
```

before code

```
tjp->proceed()
```

after code

```
class ClassA {  
public:  
    void foo(){  
        printf("ClassA::foo()\n");  
    }  
}
```

with call joinpoints:

```
advice call("void ClassA::foo()") : around()
```

before code

```
tjp->proceed()
```

after code

```
int main(){  
    printf("main()\n");  
    ClassA a;  
    a.foo();  
}
```



Introductions

advice "ClassA" : **slice class** {
 element to introduce

public:
 element to introduce
};

```
class ClassA {  
public:  
    void foo(){  
        printf("ClassA::foo()\n");  
    }  
}
```



Queue: Demanded Extensions

I. Element counting



I want Queue to
throw exceptions!

II. Errorhandling
(signaling of errors by exceptions)

III. Thread safety
(synchronization by mutex variables)



Errorhandling: The Idea

- We want to check the following constraints:
 - enqueue() is never called with a NULL item
 - dequeue() is never called on an empty queue
- In case of an error an exception should be thrown

- To implement this, we need access to ...
 - the parameter passed to enqueue()
 - the return value returned by dequeue()... from within the advice



ErrorException

```
namespace util {
    struct QueueInvalidItemError {};
    struct QueueEmptyError {};
}

aspect ErrorException {

    advice execution("% util::Queue::enqueue(...)") && args(item)
        : before(util::Item* item) {
        if( item == 0 )
            throw util::QueueInvalidItemError();
        }
    advice execution("% util::Queue::dequeue(...)") && result(item)
        : after(util::Item* item) {
        if( item == 0 )
            throw util::QueueEmptyError();
        }
};
```

ErrorException.ah



ErrorException - Elements

```
namespace util {
    struct QueueInvalidItemError {};
    struct QueueEmptyError {};
}

aspect ErrorException {

    advice execution("% util::Queue::enqueue(...)") && args(item)
        : before(util::Item* item) {
        if( item == 0 )
            throw util::QueueInvalidItemError();
    }

    advice execution("% util::Queue::dequeue(...)") && result(item)
        : after(util::Item* item) {
        if( item == 0 )
            throw util::QueueEmptyError();
    }
};
```

We give advice to be executed *before* enqueue() and *after* dequeue()

ErrorException.ah



ErrorException - Elements

```
namespace util {
  struct QueueInvalidItemEr
  struct QueueEmptyError {}
}

aspect ErrorException {

  advice execution("% util::Queue::enqueue(...)") && args(item)
    : before(util::Item* item) {
      if( item == 0 )
        throw util::QueueInvalidItemError();
    }

  advice execution("% util::Queue::dequeue(...)") && result(item)
    : after(util::Item* item) {
      if( item == 0 )
        throw util::QueueEmptyError();
    }
};
```

A context variable *item* is bound to the first argument of type *util::Item** passed to the matching methods

ErrorException.ah



ErrorException - Elements

```
namespace util {
  struct QueueInvalidItemError
  struct QueueEmptyError {}
}

aspect ErrorException {

  advice execution("% util::Queue::enqueue(...)") && args(item)
    : before(util::Item* item) {
      if( item == 0 )
        throw util::QueueInvalidItemError();
    }

  advice execution("% util::Queue::dequeue(...)") && result(item)
    : after(util::Item* item) {
      if( item == 0 )
        throw util::QueueEmptyError();
    }
};
```

Here the **context variable** *item* is bound to the **result** of type *util::Item** returned by the matching methods

ErrorException.ah



ErrorException – Lessons Learned

You have seen how to ...

- use different types of advice
 - **before** advice
 - **after** advice
- expose context in the advice body
 - by using **args** to read/modify parameter values
 - by using **result** to read/modify the return value



Queue: Demanded Extensions

I. Element counting

Queue should be thread-safe!

II. Errorhandling
(signaling of errors by exceptions)



III. Thread safety
(synchronization by mutex variables)



Thread Safety: The Idea

- Protect enqueue() and dequeue() by a mutex object
- To implement this, we need to
 - introduce a mutex variable into class Queue
 - lock the mutex before the execution of enqueue() / dequeue()
 - unlock the mutex after execution of enqueue() / dequeue()
- The aspect implementation should be exception safe!
 - in case of an exception, pending after advice is not called
 - solution: use around advice



LockingMutex

```
aspect LockingMutex {  
  advice "util::Queue" : slice class { os::Mutex lock; };  
  
  pointcut sync_methods() = "% util::Queue::%queue(...)";  
  
  advice execution(sync_methods()) && that(queue)  
  : around( util::Queue& queue ) {  
    queue.lock.enter();  
    try {  
      tjp->proceed();  
    }  
    catch(...) {  
      queue.lock.leave();  
      throw;  
    }  
    queue.lock.leave();  
  }  
};
```

LockingMutex.ah



LockingMutex - Elements

```
aspect LockingMutex {  
  advice "util::Queue" : slice class { os::Mutex lock; };  
  
  pointcut sync_methods() = "% util::Queue::%queue(...)";  
  
  advice execution(sync_methods()) && that(queue)  
  : around( util::Queue& queue ) {  
    queue.lock.enter();  
    try {  
      tjp->proceed();  
    }  
    catch(...) {  
      queue.lock.leave();  
      throw;  
    }  
    queue.lock.leave();  
  }  
};
```

We introduce a mutex member into class Queue

LockingMutex.ah



LockingMutex - Elements

```
aspect LockingMutex {
  advice "util::Queue" : slice class { os::Mutex lock; };

  pointcut sync_methods() ← "% util::Queue::%queue(...)";

  advice execution(sync_methods()) && that(queue)
  : around( util::Queue& queue ) {
    queue.lock.enter();
    try {
      tjp->proceed();
    }
    catch(...) {
      queue.lock.leave();
      throw;
    }
    queue.lock.leave();
  }
};
```

Pointcuts can be named.
sync_methods describes all methods that have to be synchronized by the mutex

LockingMutex.ah



LockingMutex - Elements

```
aspect LockingMutex {  
  advice "util::Queue" : slice class { os::Mutex lock; };  
  
  pointcut sync_methods() = "% util::Queue::%queue(...)";  
  
  advice execution(sync_methods()) && that(queue)  
  : around( util::Queue& queue ) {  
    queue.lock.enter();  
    try {  
      tjp->proceed();  
    }  
    catch(...) {  
      queue.lock.leave();  
      throw;  
    }  
    queue.lock.leave();  
  }  
};
```

`sync_methods` is used to give
around advice to the execution
of the methods

LockingMutex.ah



LockingMutex - Elements

```
aspect LockingMutex {  
  advice "util::Queue" : slice class { os::Mutex lock; };  
  
  pointcut sync_methods() = "% util::Queue::%queue(...)";  
  
  advice execution(sync_methods()) && that(queue)  
  : around( util::Queue& queue ) {  
    queue.lock.enter();  
    try {  
      tjp->proceed();  
    }  
    catch(...) {  
      queue.lock.leave();  
      throw;  
    }  
    queue.lock.leave();  
  }  
};
```

By calling `tjp->proceed()` the original method is executed

LockingMutex.ah



LockingMutex – Lessons Learned

You have seen how to ...

- use named pointcuts
 - to increase readability of pointcut expressions
 - to reuse pointcut expressions
- use around advice
 - to deal with exception safety
 - to explicit invoke (or don't invoke) the original code by calling `tjtp->proceed()`
- use wildcards in match expressions
 - `"% util::Queue::%queue(...)"` matches both `enqueue()` and `dequeue()`



Queue: A new Requirement

- I. Element counting
- II. Errorhandling
(signaling of errors by exceptions)
- III. Thread safety
(synchronization by mutex variables)
- IV. Interrupt safety
(synchronization on interrupt level)

We need Queue to be synchronized on interrupt level!



Interrupt Safety: The Idea

- Scenario
 - Queue is used to transport objects between kernel code (interrupt handlers) and application code
 - If application code accesses the queue, interrupts must be disabled first
 - If kernel code accesses the queue, interrupts must not be disabled
- To implement this, we need to distinguish
 - if the call is made from kernel code, or
 - if the call is made from application code



LockingIRQ1

```
aspect LockingIRQ {  
  
    pointcut sync_methods() = "% util::Queue::%queue(...)";  
    pointcut kernel_code() = "% kernel::%(...)";  
  
    advice call(sync_methods()) && !within(kernel_code()) : around() {  
        os::disable_int();  
        try {  
            tjp->proceed();  
        }  
        catch(...) {  
            os::enable_int();  
            throw;  
        }  
        os::enable_int();  
    }  
};
```

LockingIRQ1.ah



LockingIRQ1 – Elements

```
aspect LockingIRQ {  
  
    pointcut sync_methods() = "% util::Queue::%queue(...)";  
    pointcut kernel_code() = "% kernel::%(...)";  
  
    advice call(sync_methods()) && !within(kernel_code()) : around() {  
        os::disable_int();  
        try {  
            tjp->proceed();  
        }  
        catch(...) {  
            os::enable_int();  
            throw;  
        }  
        os::enable_int();  
    }  
};
```

We define two pointcuts. One for the methods to be synchronized and one for all kernel functions

LockingIRQ1.ah



LockingIRQ1 – Elements

```
aspect LockingIRQ {  
  
    pointcut sync_methods() = "% util::Queue::%queue(...)";  
    pointcut kernel_code() = "% kernel::%(...)";  
  
    advice call(sync_methods()) && !within(kernel_code()) : around() {  
        os::disable_int();  
        try {  
            tjp->proceed();  
        }  
        catch(...) {  
            os::enable_int();  
            throw;  
        }  
        os::enable_int();  
    }  
};
```

This pointcut expression matches any call to a *sync_method* that is **not** done from *kernel_code*

LockingIRQ1.ah



LockingIRQ1 – Result

```
util::Queue queue;
void do_something() {
    printf("do_something()\n");
    queue.enqueue( new util::Item );
}
namespace kernel {
    void irq_handler() {
        printf("kernel::irq_handler()\n");
        queue.enqueue(new util::Item);
        do_something();
    }
}
int main() {
    printf("main()\n");
    queue.enqueue(new util::Item);
    kernel::irq_handler(); // irq
    printf("back in main()\n");
    queue.dequeue();
}
```

main.cc

```
main()
os::disable_int()
> Queue::enqueue(00320FD0)
< Queue::enqueue()
os::enable_int()
kernel::irq_handler()
> Queue::enqueue(00321030)
< Queue::enqueue()
do_something()
os::disable_int()
> Queue::enqueue(00321060)
< Queue::enqueue()
os::enable_int()
back in main()
os::disable_int()
> Queue::dequeue()
< Queue::dequeue() returning 00320FD0
os::enable_int()
```

<Output>



Locking IRQ1 – Problem

```
util::Queue queue;
void do_something() {
    printf("do_something()\n");
    queue.enqueue( new util::Item );
}
namespace kernel {
    void irq_handler() {
        printf("kernel::irq_handler()\n");
        queue.enqueue(new util::Item);
        do_something();
    }
}
int main() {
    printf("main()\n");
    queue.enqueue(new util::Item);
    kernel::irq_handler(); // irq
    printf("back in main()\n");
    queue.dequeue();
}
```

main.cc

The pointcut `within(kernel_code)` does not match any **indirect** calls to `sync_methods`

```
main()
  < Queue::enqueue()
  os::enable_int()
  kernel::irq_handler()
  > Queue::enqueue(00321030)
  < Queue::enqueue()
  do_something()
  os::disable_int()
  > Queue::enqueue(00321060)
  < Queue::enqueue()
  os::enable_int()
  back in main()
  os::disable_int()
  > Queue::dequeue()
  < Queue::dequeue() returning 00320FD0
  os::enable_int()
```

<Output>



LockingIRQ2

```
aspect LockingIRQ {  
  
    pointcut sync_methods() = "% util::Queue::%queue(...)";  
    pointcut kernel_code() = "% kernel::%(...)";  
  
    advice execution(sync_methods())  
    && !cflow(execution(kernel_code())) : around() {  
        os::disable_int();  
        try {  
            tjp->proceed();  
        }  
        catch(...) {  
            os::enable_int();  
            throw;  
        }  
        os::enable_int();  
    }  
};
```

Solution

Using the **cflow** pointcut function

LockingIRQ2.ah



LockingIRQ2 – Elements

```
aspect LockingIRQ {  
  
    pointcut sync_methods() = "% util::Queue::%queue(...)";  
    pointcut kernel_code() = "% kernel::%(...)";  
  
    advice execution(sync_methods()  
    && !cflow(execution(kernel_code()))) : around() {  
        os::disable_int();  
        try {  
            tjp->proceed();  
        }  
        catch(...) {  
            os::enable_int();  
            throw;  
        }  
        os::enable_int();  
    }  
};
```

This pointcut expression matches the execution of *sync_methods* if no *kernel_code* is on the call stack. *cflow* checks the call stack (control flow) at runtime.

LockingIRQ2.ah



LockingIRQ2 – Result

```
util::Queue queue;
void do_something() {
    printf("do_something()\n");
    queue.enqueue( new util::Item );
}
namespace kernel {
    void irq_handler() {
        printf("kernel::irq_handler()\n");
        queue.enqueue(new util::Item);
        do_something();
    }
}
int main() {
    printf("main()\n");
    queue.enqueue(new util::Item);
    kernel::irq_handler(); // irq
    printf("back in main()\n");
    queue.dequeue();
}
```

main.cc

```
main()
os::disable_int()
> Queue::enqueue(00320FD0)
< Queue::enqueue()
os::enable_int()
kernel::irq_handler()
> Queue::enqueue(00321030)
< Queue::enqueue()
do_something()
> Queue::enqueue(00321060)
< Queue::enqueue()
back in main()
os::disable_int()
> Queue::dequeue()
< Queue::dequeue() returning 00320FD0
os::enable_int()
```

<Output>



LockingIRQ – Lessons Learned

You have seen how to ...

- restrict advice invocation to a specific calling context
- use the `within(...)` and `cflow(...)` pointcut functions
 - **within** is evaluated at **compile time** and returns all code joinpoints of a class' or namespaces lexical scope
 - **cflow** is evaluated at **runtime** and returns all joinpoints where the control flow is below a specific code joinpoint



AspectC++: A First Summary

- The Queue example has presented the most important features of the AspectC++ language
 - aspect, advice, joinpoint, pointcut expression, pointcut function, ...
- Additionally, AspectC++ provides some more advanced concepts and features
 - to increase the expressive power of aspectual code
 - to write broadly reusable aspects
 - to deal with aspect interdependence and ordering
- In the following, we give a short overview on these advanced language elements



3.1 Motivation: Separation of Concerns

3.2 Tutorial: AspectC++

Example Szenario

First Steps And Language Overview

Advanced Concepts

Weaver Transformations

Further Examples

3.3 Summary and Outlook

3.4 References



AspectC++: Advanced Concepts

- **Join Point API**
 - provides a uniform interface to the aspect invocation context, both at runtime and compile-time
- **Abstract Aspects and Aspect Inheritance**
 - comparable to class inheritance, aspect inheritance allows to reuse parts of an aspect and overwrite other parts
- **Generic Advice**
 - exploits static type information in advice code
- **Aspect Ordering**
 - allows to specify the invocation order of multiple aspects
- **Aspect Instantiation**
 - allows to implement user-defined aspect instantiation models



The Joinpoint API

- Inside an advice body, the current joinpoint context is available via the **implicitly passed tjp** variable:

```
advice ... {  
    struct JoinPoint {  
        ...  
    } *tjp;    // implicitly available in advice code  
    ...  
}
```

- You have already seen how to use **tjp**, to ...
 - execute the original code in around advice with **tjp->proceed()**
- The joinpoint API provides a rich interface
 - to expose context **independently** of the aspect target
 - this is especially useful in writing **reusable aspect code**



The Join Point API (Excerpt)

Types (compile-time)

```
// object type (initiator)
That
// object type (receiver)
Target
// result type of the affected function
Result
// type of the i'th argument of the affected
// function (with 0 <= i < ARGS)
Arg<i>::Type
Arg<i>::ReferredType
```

Consts (compile-time)

```
// number of arguments
ARGS
// unique numeric identifier for this join point
JPID
// numeric identifier for the type of this join
// point (AC::CALL, AC::EXECUTION, ...)
JPTYPE
```

Values (runtime)

```
// pointer to the object initiating a call
That* that()
// pointer to the object that is target of a call
Target* target()
// pointer to the result value
Result* result()
// typed pointer the i'th argument value of a
// function call (compile-time index)
Arg<i>::ReferredType* arg()
// pointer the i'th argument value of a
// function call (runtime index)
void* arg( int i )
// textual representation of the joinpoint
// (function/class name, parameter types...)
static const char* signature()
// executes the original joinpoint code
// in an around advice
void proceed()
// returns the runtime action object
AC::Action& action()
```



Abstract Aspects and Inheritance

- Aspects can inherit from other aspects...
 - Reuse aspect definitions
 - Override methods and pointcuts
- Pointcuts can be pure virtual
 - Postpone the concrete definition to derived aspects
 - An aspect with a pure virtual pointcut is called **abstract aspect**
- Common usage: Reusable aspect implementations
 - Abstract aspect defines advice code, but pure virtual pointcuts
 - Aspect code uses the joinpoint API to expose context
 - Concrete aspect inherits the advice code and overrides pointcuts



Abstract Aspects and Inheritance

```
#include "mutex.h"
aspect LockingA {
    pointcut virtual sync_classes() = 0;
    pointcut virtual sync_methods() = 0;

    advice sync_classes() : slice class {
        os::Mutex lock;
    };
    advice execution(sync_methods()) : around() {
        tjp->that()->lock.enter();
        try {
            tjp->proceed();
        }
        catch(...) {
            tjp->that()->lock.leave();
            throw;
        }
        tjp->that()->lock.leave();
    }
};
```

LockingA.ah

The abstract locking aspect declares two **pure virtual pointcuts** and uses the **joinpoint API** for an context-independent advice implementation.

```
#include "LockingA.ah"
aspect LockingQueue : public LockingA {
    pointcut sync_classes() =
        "util::Queue";
    pointcut sync_methods() =
        "% util::Queue::%queue(...)";
};
```

LockingQueue.ah



Abstract Aspects and Inheritance

```
#include "mutex.h"
aspect LockingA {
    pointcut virtual sync_classes() = 0;
    pointcut virtual sync_methods() = 0;

    advice sync_classes() : slice class {
        os::Mutex lock;
    };
    advice execution(sync_methods()) : around() {
        tjp->that()->lock.enter();
        try {
            tjp->proceed();
        }
        catch(...) {
            tjp->that()->lock.leave();
            throw;
        }
        tjp->that()->lock.leave();
    }
};
```

LockingA.ah

The concrete locking aspect **derives** from the abstract aspect and **overrides** the pointcuts.

```
#include "LockingA.ah"
aspect LockingQueue : public LockingA {
    pointcut sync_classes() =
        "util::Queue";
    pointcut sync_methods() =
        "% util::Queue::%queue(...)";
};
```

LockingQueue.ah



Generic Advice

Uses static JP-specific type information in advice code

- in combination with C++ overloading
- to instantiate C++ templates and template meta-programs

```
aspect TraceService {  
  advice call(...) : after() {  
    ...  
    cout << *tjp->result();  
  }  
};
```

... operator <<(..., **int**)

... operator <<(..., **long**)

... operator <<(..., **bool**)

... operator <<(..., **Foo**)



Generic Advice

Uses static JP-specific type information in advice code

- in combination with C++ overloading

Resolves to the **statically typed** return value of the template meta-programs

- no runtime type checks are needed
- unhandled types are detected at compile-time
- functions can be inlined

```
aspect TraceService {  
    advice call(...) : after() {  
        ...  
        cout << *tjp->result();  
    }  
};
```

... operator <<(..., int)

... operator <<(..., long)

... operator <<(..., bool)

... operator <<(..., Foo)



Aspect Ordering

- Aspects should be independent of other aspects
 - However, sometimes inter-aspect dependencies are unavoidable
 - Example: Locking should be activated before any other aspects
- Order advice
 - The aspect order can be defined by **order advice**
`advice pointcut-expr : order(high, ..., low)`
 - Different aspect orders can be defined for different pointcuts
- Example

```
advice "% util::Queue::%queue(...)"  
      : order( "LockingIRQ", "%" && !"LockingIRQ" );
```



Aspect Instantiation

- Aspects are singletons by default
 - **aspectof()** returns pointer to the one-and-only aspect instance
- By overriding aspectof() this can be changed
 - e.g. one instance per client or one instance per thread

```
aspect MyAspect {  
    // ....  
    static MyAspect* aspectof() {  
        static __declspec(thread) MyAspect* theAspect;  
        if( theAspect == 0 )  
            theAspect = new MyAspect;  
        return theAspect;  
    }  
};
```

MyAspect.ah

Example of an user-defined aspectof() implementation for per-thread aspect instantiation by using thread-local storage.

(Visual C++)



3.1 Motivation: Separation of Concerns

3.2 Tutorial: AspectC++

Example Szenario

First Steps And Language Overview

Advanced Concepts

Weaver Transformations

Further Examples

3.3 Summary and Outlook

3.4 References



Aspect Transformation

```
aspect Transform {  
  advice call("% foo()") : before() {  
    printf("before foo call\n");  
  }  
  advice execution("% C::%()") : after()  
{  
    printf(tjp->signature ());  
  }  
};
```

Transform.ah

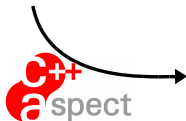

```
class Transform {  
  static Transform __instance;  
  // ...  
  void __a0_before () {  
    printf ("before foo call\n");  
  }  
  template<class JoinPoint>  
  void __a1_after (JoinPoint *tjp) {  
    printf (tjp->signature ());  
  }  
};
```

Transform.ah'



Aspect Transformation

```
aspect Transform {  
  advice call("% foo()") : before() {  
    printf("before foo call\n");  
  }  
  advice execution("% C::%()") : after()  
{  
    printf(tjtp->signature ());  
  }  
};
```

Transform.ah



```
class Transform {  
  static Transform __instance;  
  // ...  
  void __a0_before () {  
    printf ("before foo call\n");  
  }  
  template<class JoinPoint>  
  void __a1_after (JoinPoint *tjtp) {  
    printf (tjtp->signature ());  
  }  
};
```

Transform.ah'

Aspects are transformed
into **ordinary classes**

Aspect Transformation

```
aspect Transform {  
  advice call("% foo()") : before() {  
    printf("before foo call\n");  
  }  
  advice execution("% C::%()") : after()  
{  
    printf(tjp->signature ());  
  }  
};
```

Transform.ah



```
class Transform {  
  static Transform __instance;  
  // ...  
  void __a0_before () {  
    printf ("before foo call\n");  
  }  
  template<class JoinPoint>  
  void __a1_after (JoinPoint *tjp) {  
    printf (tjp->signature ());  
  }  
};
```

Transform.ah'

One global aspect **instance** is created by default

Aspect Transformation

```
aspect Transform {  
  advice call("% foo()") : before() {  
    printf("before foo call\n");  
  }  
  advice execution("% C::%()") : after()  
{  
    printf(tjp->signature ());  
  }  
};
```

Transform.ah



```
class Transform {  
  static Transform __instance;  
  // ...  
  void __a0_before () {  
    printf ("before foo call\n");  
  }  
  template<class JoinPoint>  
  void __a1_after (JoinPoint *tjp) {  
    printf (tjp->signature ());  
  }  
};
```

Transform.ah'

Advice becomes a
member function

Aspect Transformation

```
aspect Transform {  
  advice call("% foo()") : before() {  
    printf("before foo call\n");  
  }  
  advice execution("% C::%()") : after()  
{  
    printf(tjtp->signature ());  
  }  
};
```

Transform.ah



“Generic Advice”
becomes a **template**
member function

```
class Transform {  
  static Transform __instance;  
  // ...  
  void __a0_before () {  
    printf ("before foo call\n");  
  }  
  template<class JoinPoint>  
  void __a1_after (JoinPoint *tjtp) {  
    printf (tjtp->signature ());  
  }  
};
```

Transform.ah'

Joinpoint Transformation

```
int main() {  
    foo();  
    return 0;  
}
```

main.cc



```
int main() {  
    struct __call_main_0_0 {  
        static inline void invoke () {  
            AC::..._a0_before ();  
            ::foo();  
        }  
    };  
    __call_main_0_0::invoke ();  
    return 0;  
}
```

main.cc'



Joinpoint Transformation

```
int main() {  
    foo();  
    return 0;  
}
```

main.cc



the function call is replaced by
a call to a wrapper function

```
int main() {  
    struct __call_main_0_0 {  
        static inline void invoke () {  
            AC::..._a0_before ();  
            ::foo();  
        }  
    };  
    __call_main_0_0::invoke ();  
    return 0;  
}
```

main.cc'



Joinpoint Transformation

```
int main() {  
    foo();  
    return 0;  
}
```

main.cc



a local class invokes the advice code for this joinpoint

```
int main() {  
    struct __call_main_0_0 {  
        static inline void invoke () {  
            AC::..._a0_before ();  
            ::foo();  
        }  
    };  
    __call_main_0_0::invoke ();  
    return 0;  
}
```

main.cc'



Translation Modes

➤ Whole Program Transformation-Mode

- e.g. `ac++ -p src -d gen -e cpp -Iinc -DDEBUG`
- transforms whole directory trees
- generates manipulated headers, e.g. for libraries
- can be chained with other whole program transformation tools

➤ Single Translation Unit-Mode

- e.g. `ac++ -c a.cc -o a-gen.cc -p .`
- easier integration into build processes



3.1 Motivation: Separation of Concerns

3.2 Tutorial: AspectC++

Example Szenario

First Steps And Language Overview

Advanced Concepts

Weaver Transformations

Further Examples

3.3 Summary and Outlook

3.4 References



Observer Pattern: Scenario

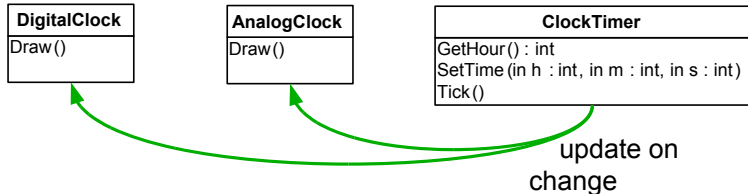

Observer Pattern: Implementation

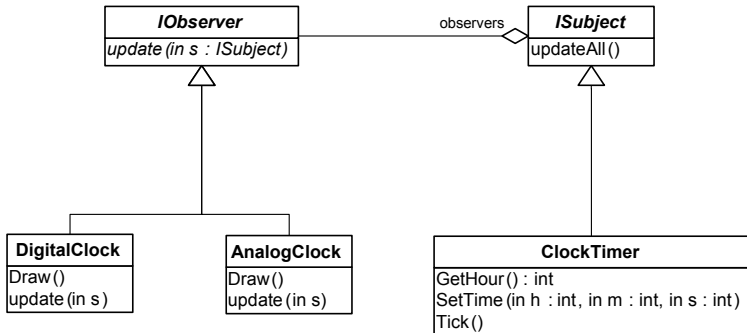

Observer Pattern: Problem

The 'Observer Protocol' Concern...

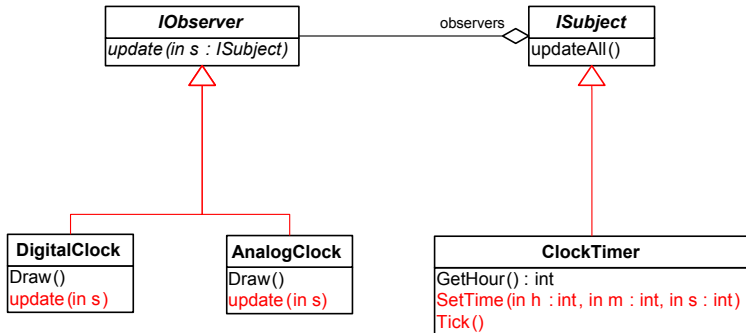

...**crosscuts** the module structure



Solution: Generic Observer Aspect

```
aspect ObserverPattern {
    ...
public:
    struct ISubject {};
    struct IObserver {
        virtual void update (ISubject *) = 0;
    };

    pointcut virtual observers() = 0;
    pointcut virtual subjects() = 0;

    pointcut virtual subjectChange() = execution( "% ..:::%(...)"
        && !"%" ..:::%(...) const" ) && within( subjects() );

    advice observers () : slice class : public ObserverPattern::IObserver;
    advice subjects() : slice class : public ObserverPattern::ISubject;

    advice subjectChange() : after () {
        ISubject* subject = tjp->that();
        updateObservers( subject );
    }

    void updateObservers( ISubject* subject ) { ... }
    void addObserver( ISubject* subject, IObserver* observer ) { ... }
    void remObserver( ISubject* subject, IObserver* observer ) { ... }
};
```



Solution: Generic Observer Aspect

```
aspect ObserverPattern {
  ...
  public:
  struct ISubject {};
  struct IObserver {
    virtual void update (ISubject *) = 0;
  };

  pointcut virtual observers() = 0;
  pointcut virtual subjects() = 0;

  pointcut virtual subjectChange() = execution( "% ...::%(...)"
    && !" % ...::%(...) const" ) && within( subjects() );

  advice observers () : slice class : public ObserverPattern::IObserver;
  advice subjects() : slice class : public ObserverPattern::ISubject;

  advice subjectChange() : after () {
    ISubject* subject = tjp->that();
    updateObservers( subject );
  }

  void updateObservers( ISubject* subject ) { ... }
  void addObserver( ISubject* subject, IObserver* observer ) { ... }
  void remObserver( ISubject* subject, IObserver* observer ) { ... }
};
```

**Interfaces for the
subject/observer roles**



Solution: Generic Observer Aspect

```
aspect ObserverPattern {
    ...
public:
    struct ISubject {};
    struct IObserver {
        virtual void update (ISubject *) = 0;
    };

    pointcut virtual observers() = 0;
    pointcut virtual subjects() = 0;

    pointcut virtual subjectChange() = execution( "% ..:::%(...)"
        && !"%" ..:::%(...) const" ) && within( subjects() );

    advice observers () : slice class : public ObserverPattern::IObserver;
    advice subjects() : slice class : public ObserverPattern::ISubject;

    advice subjectChange() : after () {
        ISubject* subject = tjp->that();
        updateObservers( subject );
    }

    void updateObservers( ISubject* subject ) { ... }
    void addObserver( ISubject* subject, IObserver* observer ) { ... }
    void remObserver( ISubject* subject, IObserver* observer ) { ... }
};
```

abstract pointcuts that
define subjects/observers
(need to be overridden by a
derived aspect)

pointcut virtual observers() = 0;
pointcut virtual subjects() = 0;



Solution: Generic Observer Aspect

```
aspect ObserverPattern {  
    ...  
    public:  
        struct ISubject { };  
        struct IObserver {  
            virtual void update (ISubject *) = 0;  
        };  
  
        pointcut virtual observers() = 0;  
        pointcut virtual subjects() = 0;  
  
        pointcut virtual subjectChange() = execution( "% ...:~:(...)"  
            && !"~:~:(...) const" ) && within( subjects() );  
  
        advice observers () : slice class : public ObserverPattern::IObserver;  
        advice subjects()   : slice class : public ObserverPattern::ISubject;  
  
        advice subjectChange() : after () {  
            ISubject* subject = tjp->that();  
            updateObservers( subject );  
        }  
  
        void updateObservers( ISubject* subject ) { ... }  
        void addObserver( ISubject* subject, IObserver* observer ) { ... }  
        void remObserver( ISubject* subject, IObserver* observer ) { ... }  
};
```

virtual pointcut defining all state-changing methods.

(Defaults to the execution of any non-const method in subjects)

pointcut virtual subjectChange() = execution("% ...:~:(...)" && !"~:~:(...) const") && within(subjects());

advice observers () : slice class : public ObserverPattern::IObserver;
advice subjects() : slice class : public ObserverPattern::ISubject;

advice subjectChange() : after () {
 ISubject* subject = tjp->that();
 updateObservers(subject);
}

void updateObservers(ISubject* subject) { ... }
void addObserver(ISubject* subject, IObserver* observer) { ... }
void remObserver(ISubject* subject, IObserver* observer) { ... }

Solution: Generic Observer Aspect

```
aspect ObserverPattern {
    ...
public:
    struct ISubject {};
    struct IObserver {
        virtual void update (ISubject *) = 0;
    };
    pointcut virtual observers() = 0;
    pointcut virtual subjects() = 0;
    pointcut virtual subjectChange() = execution( "% ...::%(...)"
        && !"%" ...::%(...) const" ) && within( subjects() );
    advice observers () : slice class : public ObserverPattern::IObserver;
    advice subjects() : slice class : public ObserverPattern::ISubject;
    advice subjectChange() : after () {
        ISubject* subject = tjp->that();
        updateObservers( subject );
    }
    void updateObservers( ISubject* subject ) { ... }
    void addObserver( ISubject* subject, IObserver* observer ) { ... }
    void remObserver( ISubject* subject, IObserver* observer ) { ... }
};
```

Introduction of the role interface as additional **baseclass** into subjects / observers



Solution: Generic Observer Aspect

```
aspect ObserverPattern {
    ...
public:
    struct ISubject {};
    struct IObserver {
        virtual void update (ISubject *) = 0;
    };

    pointcut virtual observers() = 0;
    pointcut virtual subjects() = 0;

    pointcut virtual subjectChange() = execution( "% ..:::~(...)"
        && !"~ ..:::~(...)" const ) && within( subjects() );

    advice observers () : slice class : public ObserverPattern::IObserver;
    advice subjects() : slice class : public ObserverPattern::ISubject;

    advice subjectChange() : after () {
        ISubject* subject = tjp->that();
        updateObservers( subject );
    }

    void updateObservers( ISubject* subject ) { ... }
    void addObserver( ISubject* subject, IObserver* observer ) { ... }
    void remObserver( ISubject* subject, IObserver* observer ) { ... }
};
```

After advice to update
observers after
execution of a state-
changing method



Solution: Putting Everything Together

Applying the Generic Observer Aspect to the clock example

```
aspect ClockObserver : public ObserverPattern {
    // define the participants
    pointcut subjects() = "ClockTimer";
    pointcut observers() = "DigitalClock"|"AnalogClock";
public:
    // define what to do in case of a notification
    advice observers() : slice class {
    public:
        void update( ObserverPattern::ISubject* s ) {
            Draw();
        }
    };
};
```



Errorhandling in Legacy Code: Scenario

```
LRESULT WINAPI WndProc( HWND hWnd, UINT nMsg, WPARAM wParam, LPARAM lParam ) {
    HDC dc = NULL; PAINTSTRUCT ps = {0};

    switch( nMsg ) {
        case WM_PAINT:
            dc = BeginPaint( hWnd, &ps );
            ...
            EndPaint(hWnd, &ps);
            break;
        ...
    }
}

int WINAPI WinMain( ... ) {
    HANDLE hConfigFile = CreateFile( "example.config", GENERIC_READ, ... );

    WNDCLASS wc = {0, WndProc, 0, 0, ... , "Example_Class"};
    RegisterClass( &wc );
    HWND hwndMain = CreateWindowEx( 0, "Example_Class", "Example", ... );
    UpdateWindow( hwndMain );

    MSG msg;
    while( GetMessage( &msg, NULL, 0, 0 ) ) {
        TranslateMessage( &msg );
        DispatchMessage( &msg );
    }
    return 0;
}
```

A typical Win32 application



Errorhandling in Legacy Code: Scenario

```
LRESULT WINAPI WndProc( HWND hWnd, UINT nMsg, WPARAM wParam, LPARAM lParam ) {
    HDC dc = NULL; PAINTSTRUCT ps = {0};

    switch( nMsg ) {
        case WM_PAINT:
            dc = BeginPaint( hWnd, &ps );
            ...
            EndPaint(hWnd, &ps);
            break;
        ...
    }
}

int WINAPI WinMain( ... ) {
    HANDLE hConfigFile = CreateFile( "example.config", GENERIC_READ, ... );

    WNDCLASS wc = {0, WndProc, 0, 0, ... , "Example_Class"};
    RegisterClass( &wc );
    HWND hwndMain = CreateWindowEx( 0, "Example_Class", "Example", ... );
    UpdateWindow( hwndMain );

    MSG msg;
    while( GetMessage( &msg, NULL, 0, 0 ) ) {
        TranslateMessage( &msg );
        DispatchMessage( &msg );
    }
    return 0;
}
```

These Win32 API functions may fail!



Win32 Errorhandling: Goals

- Detect failed calls of Win32 API functions
 - by giving after advice for any call to a Win32 function
- Throw a *helpful* exception in case of a failure
 - describing the exact circumstances and reason of the failure

Problem: Win32 failures are indicated by a “magic” return value

- magic value to compare against depends on the **return type** of the function
- error reason (GetLastError()) only valid in case of a failure

return type	magic value
BOOL	FALSE
ATOM	(ATOM) 0
HANDLE	INVALID_HANDLE_VALUE or NULL
HWND	NULL



Detecting the failure: Generic Advice

```
advice call(win32API ()) :  
after () {  
    if (isError (*tjp->result()))  
        // throw an exception  
}
```

bool isError(ATOM);

bool isError(BOOL);

bool isError(HANDLE);

bool isError(HWND);

...



Describing the failure: Generative Advice

```
template <int I> struct ArgPrinter {  
    template <class JP> static void work (JP &tjp, ostream &s) {  
        ArgPrinter<I-1>::work (tjp, s);  
        s << ", " << *tjp. template arg<I-1>();  
    }  
};
```

```
advice call(win32API ()) : after () {  
    // throw an exception  
    ostringstream s;  
    DWORD code = GetLastError();  
    s << "WIN32 ERROR " << code << ...  
      << win32::GetErrorText( code ) << ... <<  
      << tjp->signature() << "WITH: " << ...;  
    ArgPrinter<JoinPoint::ARGS>::work (*tjp, s);  
  
    throw win32::Exception( s.str() );  
}
```



Reporting the Error

```
LRESULT WINAPI WndProc( HWND hWnd, UINT nMsg, WPARAM wParam, LPARAM lParam ) {
    HDC dc = NU

    switch( nMs
    case WM_P
        dc = Be
        ...
        EndPain
        break;
    ...
}

int WINAPI WinMain( ... ) {
    HANDLE hConfigFile = CreateFile( "example.config", GENERIC_READ, ... );

    WNDCLASS wc = {0, WndProc, 0, 0, ... , "Example_Class"};
    RegisterClass( &wc );
    HWND hwndMain = CreateWindowEx( 0, "Example_Class", "Example", ... );
    UpdateWindow( hwndMain );

    MSG msg;
    while( GetMessage( &msg, NULL, 0, 0 ) ) {
        TranslateMessage( &msg );
        DispatchMessage( &msg );
    }
    return 0;
}
```

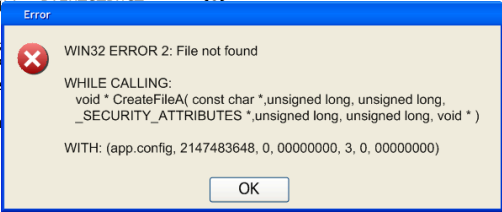

Agenda

- 3.1 Motivation: Separation of Concerns
- 3.2 Tutorial: AspectC++
- 3.3 Summary and Outlook**
- 3.4 References



Aspect-Oriented Programming: Summary

- AOP aims at a better separation of crosscutting concerns
 - Avoidance of code tangling
 - ↳ implementation of optional features
 - Avoidance of code scattering
 - ↳ implementation of nonfunctional features
- Basic idea: separation of **what** from **where**
 - **Join Points** ↳ **where**
 - positions in the static structure or dynamic control flow (event)
 - given declaratively by pointcut expressions
 - **Advice** ↳ **what**
 - additional elements (members, ...) to introduce at join points
 - additional behavior (code) to superimpose at join points
- AspectC++ brings AOP concepts to the C++ world
 - Static source-to-source transformation approach



Aspect-Oriented Programming: Summary

- AOP aims at a better separation of crosscutting concerns
 - Avoidance of code tangling
 - ↳ implementation of optional features
 - Avoidance of code scattering
 - ↳ implementation of nonfunctional features
- Basic idea: separation of **what** from **where**
 - **Join Points** ↳ **where**
 - positions in the static structure or dynamic control flow (event)
 - given declaratively by pointcut expressions
 - **Advice** ↳ **what**
 - additional elements (members, ...) to introduce at join points
 - additional behavior (code) to superimpose at join points
- AspectC++ brings AOP concepts to the C++ world
 - Static source-to-source transformation approach

Next Lecture:

How to use AOP to achieve loose coupling, granularity and variability for feature implementations in configurable system software

↳ **aspect-aware design**



- [1] The British Standards Institute. *The C++ Standard (Incorporating Technical Corrigendum No. 1)*. second. Printed version of the ISO/IEC 14882:2003 standard. John Wiley & Sons, Inc., 2003. ISBN: 0-470-84674-7.
- [2] Gregor Kiczales, John Lamping, Anurag Mendhekar, et al. "Aspect-Oriented Programming". In: *Proceedings of the 11th European Conference on Object-Oriented Programming (ECOOP '97)*. (Finland). Ed. by Mehmet Aksit and Satoshi Matsuoka. Vol. 1241. Lecture Notes in Computer Science. Springer-Verlag, June 1997, pp. 220–242.
- [3] Daniel Lohmann, Georg Blaschke, and Olaf Spinczyk. "Generic Advice: On the Combination of AOP with Generative Programming in AspectC++". In: *Proceedings of the 3rd International Conference on Generative Programming and Component Engineering (GPCE '04)*. Ed. by G. Karsai and E. Visser. Vol. 3286. Lecture Notes in Computer Science. Springer-Verlag, Oct. 2004, pp. 55–74. ISBN: 978-3-540-23580-4. DOI: [10.1007/978-3-540-30175-2_4](https://doi.org/10.1007/978-3-540-30175-2_4).
- [4] Daniel Lohmann, Fabian Scheler, Reinhard Tartler, et al. "A Quantitative Analysis of Aspects in the eCos Kernel". In: *Proceedings of the ACM SIGOPS/EuroSys European Conference on Computer Systems 2006 (EuroSys '06)*. (Leuven, Belgium). Ed. by Yolande Berbers and Willy Zwaenepoel. New York, NY, USA: ACM Press, Apr. 2006, pp. 191–204. ISBN: 1-59593-322-0. DOI: [10.1145/1218063.1217954](https://doi.org/10.1145/1218063.1217954).



- [5] Olaf Spinczyk and Daniel Lohmann. “The Design and Implementation of AspectC++”. In: *Knowledge-Based Systems, Special Issue on Techniques to Produce Intelligent Secure Software* 20.7 (2007), pp. 636–651. DOI: 10.1016/j.knosys.2007.05.004.
- [6] Olaf Spinczyk, Daniel Lohmann, and Matthias Urban. “AspectC++: An AOP Extension for C++”. In: *Software Developers Journal* 5 (May 2005), pp. 68–76. URL: <http://www.aspectc.org/fileadmin/publications/sdj-2005-en.pdf>.

